

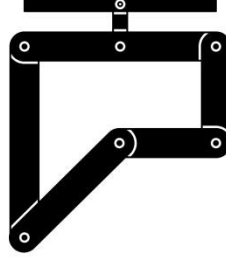

Robendy



Medical Device

## **Surgery robot with 9 degrees of freedom**

The Robendy product is a 9 degrees of freedom surgery robot with different sizes, and any movement that the doctor can do with his/her wrist. This robot can help doctors with high and smooth operation speed, and its movement can be also remotely control for telesurgery with the help of the program. This robot performs the rotation motion with any angle and changes the angle during rotation and increases and decreases the diameter and transverse motion completely.



## WHAT IS PROBLEM WE ARE FOCUSING ON?

DUE TO THE FACT THAT MEDICAL SCIENCE IS GROWING TOWARDS SURGERY WITH THE HELP OF ROBOTS AND INSTRUMENTS WITH SOFT MEDICAL MOVEMENT AND HIGH SPEED AND CONTROL WITH THE HELP OF THE PROGRAM, THE DOCTOR CAN EASILY CONTROL THE INSTRUMENT WITH A MOVEMENT SUCH AS HAND MOVEMENTS. BUT MOST OF THE CURRENT ROBOTS HAVE THE PROBLEMS OF ACCESSING BLIND SPOTS AND THE DEGREE OF FREEDOM.

ROBENDY FOCUSES ON THIS GAP TO INVENT A SURGERY ROBOT WHICH CAN BE MANUFACTURED IN DIFFERENT SIZES FOR DIFFERENT TYPES OF SURGERIES.

# SOLUTION?

Wrist surgery robot has 9 degrees of freedom in different sizes for helping doctor to access any blind spot and movements. This robot gives the doctor an ability of high, smooth, and precise actions in the process of operation, which can be controlled manually by hands and remotely by program. It can perform the rotation motion with any angles and changes, change the angle during rotation, and increases and decreases the diameter and transverse motion completely.



# WHY CUSTOMERS SHOULD BUY YOUR PRODUCT?

1. Speed of operation and high accuracy of this robot.
2. Remote control of this robot with the help of the program
3. 9 degrees of freedom movements at any time together.
4. Rotate the medical instrument to the degree of blind spot that the physician needs.
5. Different sizes of this robot are available for different types of surgeries.

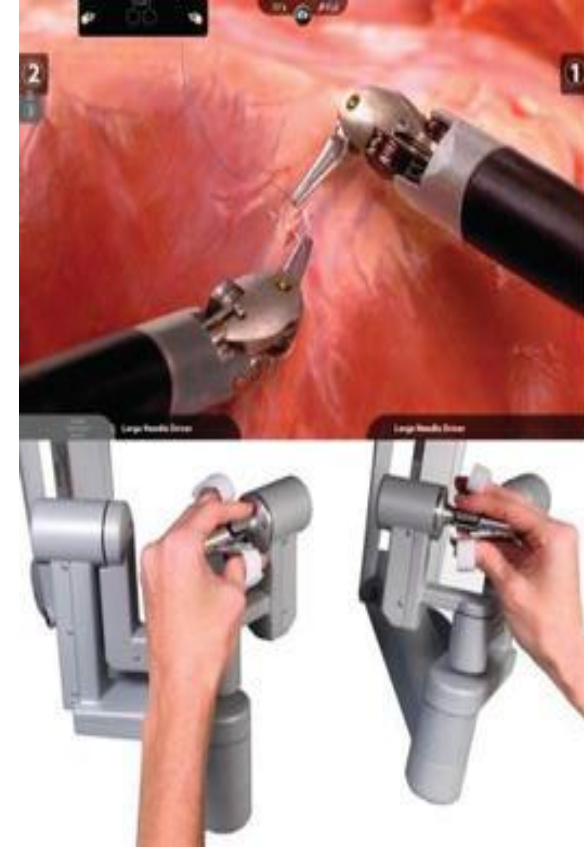
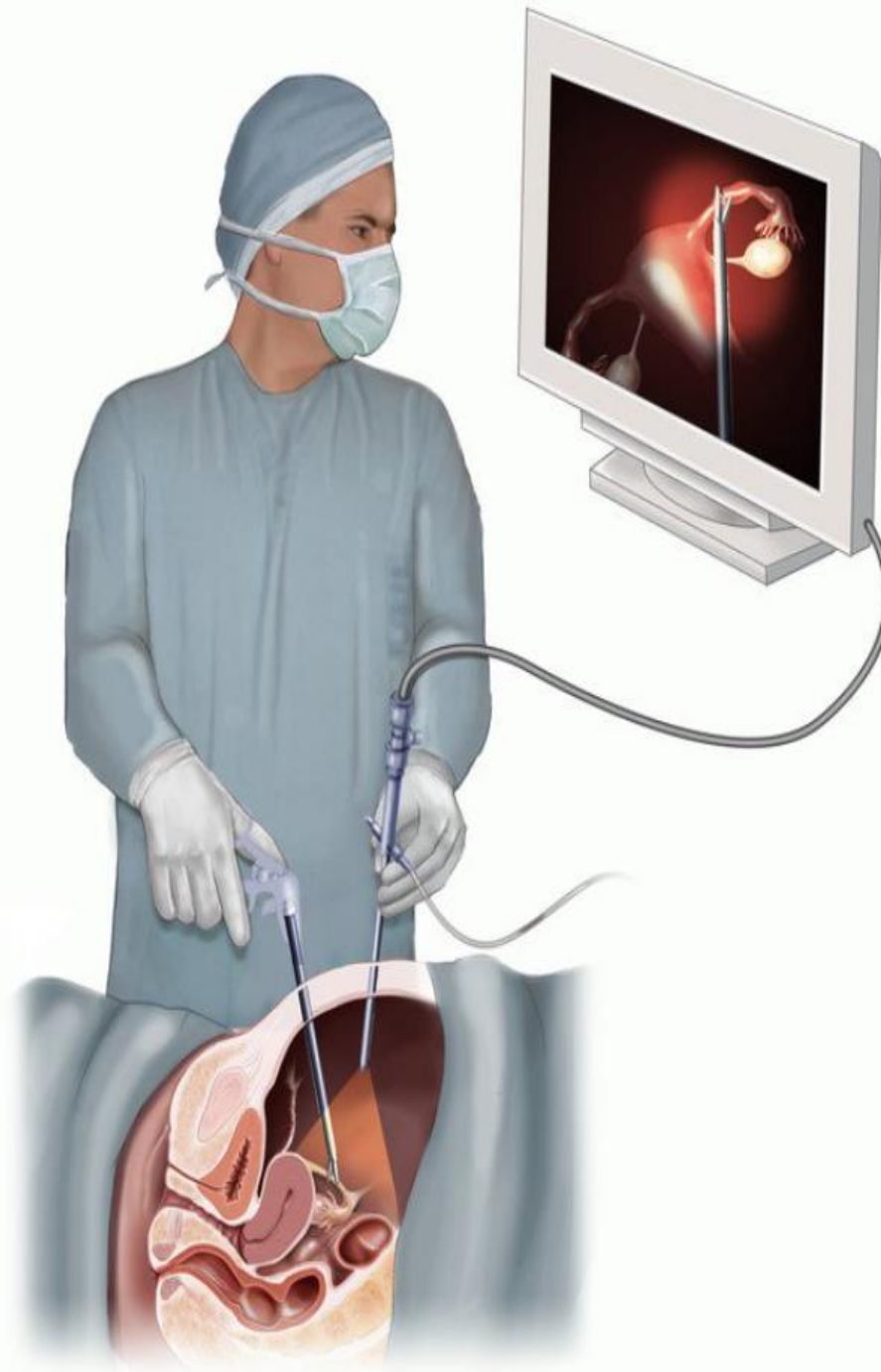

# WHAT IS INNOVATIVE POINT OF YOUR PRODUCT?

1. 9 degrees of motion at the same time rotation, diameter increment , transverse and longitudinal motion, and change of rotation angle.
2. It can be utilized for manual and tele surgeries.
3. Smooth movements of this robot with high operating speed.

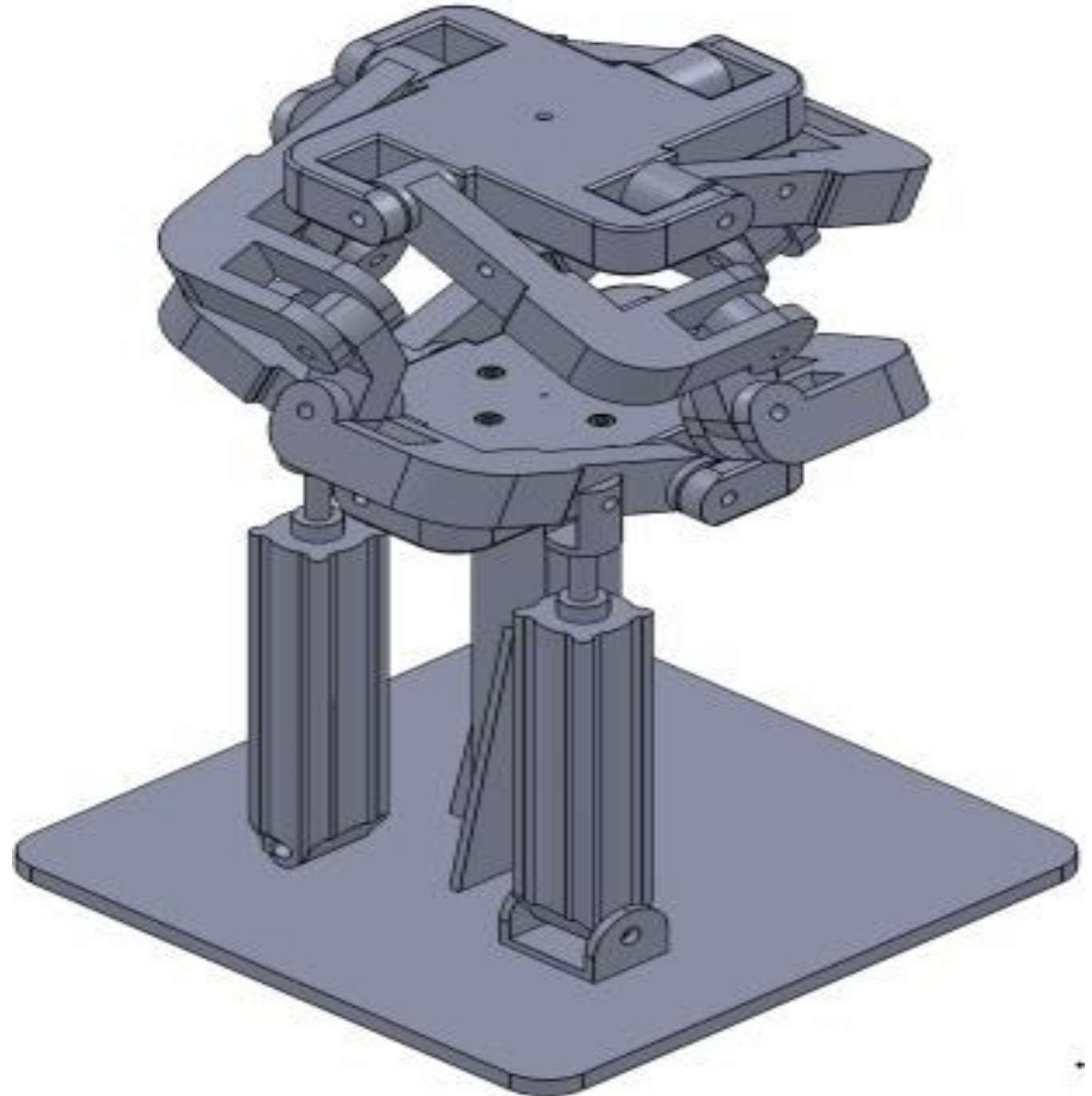

# ROBENDY TEAM



**Hamid reza Rezaei**  
*Chief of Executive  
Manager*



**Amir Piryaei**  
*Head of  
Operation  
Department*



**Mahdi Goodarzi**  
*Head of  
Research and  
Development*



**Mohammad Torkashvand**  
*Head of Technical Design  
and Engineering Department*

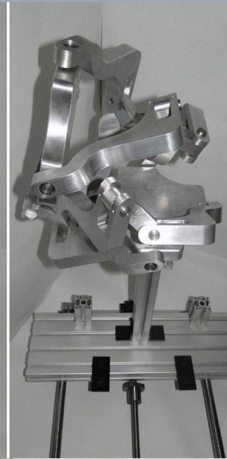
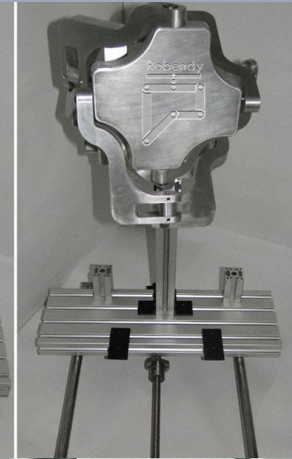
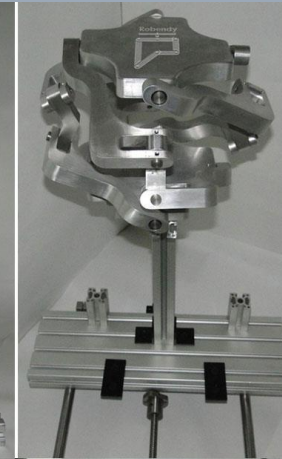
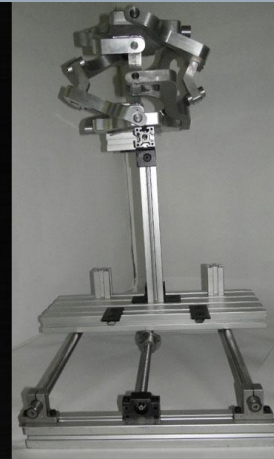



Robendy

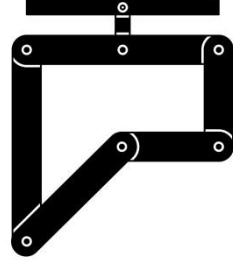

# THANK YOU

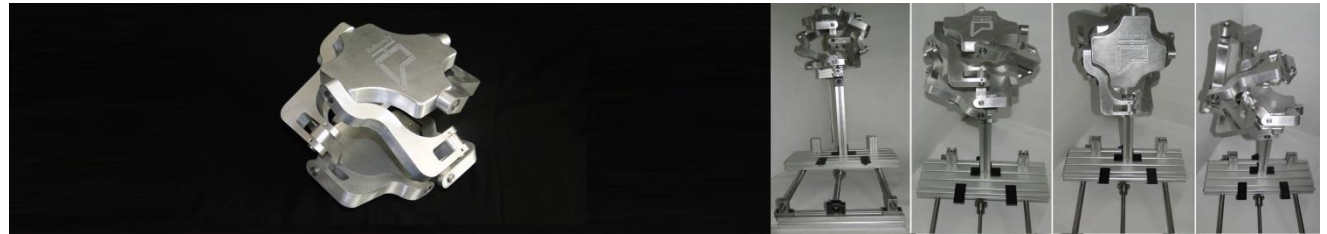

[Robendy.contact@gmail.com](mailto:Robendy.contact@gmail.com)

<https://www.linkedin.com/company/robendy>